

## Cable Clamp Details

There are three different types of cable clamp arrangements that are acceptable for use on Kinetics Noise Control cable restraint systems. These are factory swaged, clamped with U-bolt cable clips, and connections made using seismically rated “Gripple” connectors. Other types of connections have either not been tested, or when tested do not meet the capacity standards required for consistent performance.

### Factory-Swaged Connections

When so ordered, one end of a cable assembly can be obtained with a factory-swaged connection. Crimping a zinc-coated copper or a stainless steel sleeve onto a cable loop at the termination point makes these connections. Multiple crimp locations are required with the actual number varying based on the cable size. To obtain a seismic rating, these swaged connections must be performed using the appropriate calibrated hydraulic press and must not use aluminum sleeves. Field-swaged connections and in particular those made using hand crimping tools are not suitable for seismic applications. All Kinetics Noise Control computed seismic certifications are based on capacities obtained from components provided by Kinetics Noise Control. No certifications can be offered on components crimped by others.

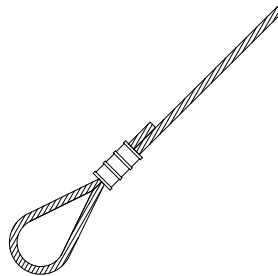

**Swaged Connector**

### U-Bolt Cable Clip Connections

For larger cables, as an option to the seismically rated “Gripple” on smaller cables, and where field connections are necessary or desired, U-bolt cable clips can be used. When used, a minimum of three clips is required per connection for sizes up to 3/8” cable. For 1/2” cables a minimum of four clips is required per connection.

## CABLE CLAMP DETAILS

PAGE 1 OF 7

RELEASE DATE: 10/17/05



DUBLIN, OHIO, USA • MISSISSAUGA, ONTARIO, CANADA

Toll Free (USA only): 800-959-1229  
International: 614-889-0480  
Fax: 614-889-0540  
World Wide Web: [www.kineticsnoise.com](http://www.kineticsnoise.com)  
Email: [sales@kineticsnoise.com](mailto:sales@kineticsnoise.com)

DOCUMENT:

**D9.5.2**



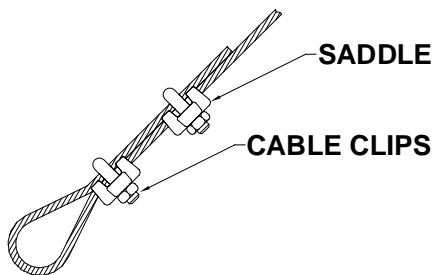

**U-Bolt Cable Clips**

When fitting cable clips, the saddle side of the clip must always be against the “live” portion of the cable. The “live” side of the cable is the side that does not terminate at the connection, but continues to the clip at the opposite end.

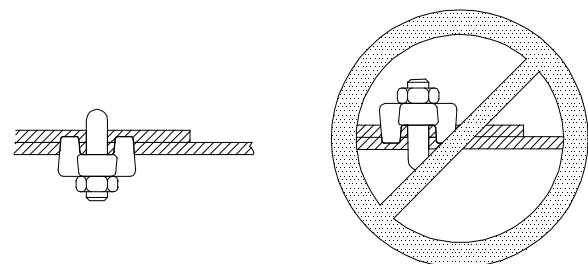

**CORRECT  
INSTALLATION**

**NOT LIKE  
THIS**

Failure to orient the clip in the proper fashion will cause premature failure of the cable assembly.

While proper tightening of the clip nuts and adequate turnback (or overlap) length of the cable is important, tests conducted have found that it is not as critical for seismic applications as it is for lifting applications. Reasonable variations from the values listed below have a minimal impact on the capacity of the connection. Below is a table with the desired minimum tightening torques recommended by clip manufacturers, clip quantities, and turnback lengths listed for various sized cables.

Cable Size in Inches	Minimum Number of Clips	Amount of Rope Turnback/Inches	Minimum Torque in Ft. Lbs.
1/8	3	3-3/4	3
3/16	3	3-3/4	4.5
1/4	3	4-3/4	15
3/8	3	6-1/2	30
1/2	4	11-1/2	45

**CABLE CLAMP DETAILS**



Toll Free (USA only): 800-959-1229  
 International: 614-889-0480  
 Fax: 614-889-0540  
 World Wide Web: [www.kineticsnoise.com](http://www.kineticsnoise.com)  
 Email: [sales@kineticsnoise.com](mailto:sales@kineticsnoise.com)



## “Gripple” Connections

For smaller cables (up to 5mm (metric) and up to 3/16” (English)), special proprietary “Gripple” connection clips can be used. These clips offer significant benefits in speed of installation and can be used in a large variety of common light-duty applications. When using “Gripple” connectors or “Gripple” restraint connection kits, it is critical that seismically rated components are used. While Kinetics Noise Control offers only seismically rated components, those supplied by others may not be. “Gripple” connectors for sizes in excess of 5mm or 3/16” are not appropriate for seismic installations as they will not seat properly and consistently without the application of a constant tensile load.

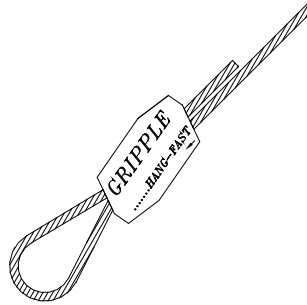

**Gripple Connector**

### GRIPPLE Installation Procedure

- 1) Feed the proper sized cable as provided by Kinetics Noise Control through the Gripple as shown.

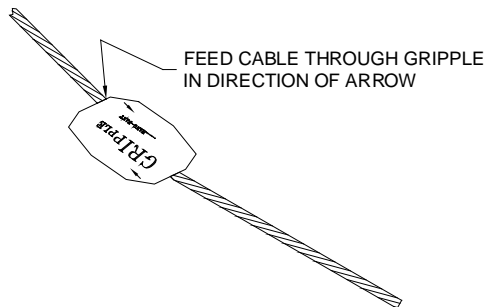

- 2) Loop the cable through the attachment bracket or hardware. If the cable rides against any sharp corners (not counting the hole in the Kinetics Noise Control provided bracket itself) or is subject to excessive vibration in service, fit the Kinetics Noise Control provided thimble in the loop and then feed the cable back through the opposite side of the GRIPPLE.

### CABLE CLAMP DETAILS

PAGE 3 OF 7

RELEASE DATE: 10/17/05



DUBLIN, OHIO, USA • MISSISSAUGA, ONTARIO, CANADA

Toll Free (USA only): 800-959-1229  
International: 614-889-0480  
Fax: 614-889-0540  
World Wide Web: [www.kineticsnoise.com](http://www.kineticsnoise.com)  
Email: [sales@kineticsnoise.com](mailto:sales@kineticsnoise.com)

DOCUMENT:

D9.5.2



LOOP CABLE AROUND BRACKET  
(INSERT THIMBLE IF CABLE RUBS  
ON A SHARP CORNER OR VIBRATION  
IS AN ISSUE) AND THEN FEED  
CABLE BACK THROUGH GRIPPLE IN  
DIRECTION OF ARROW

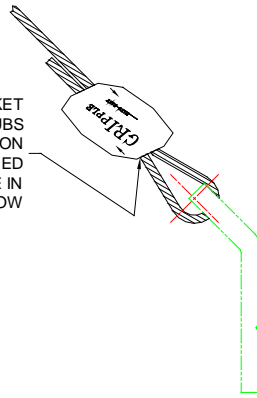

- 3) Remove the slack from the cable by slipping the cable through the GRIPPLE, but leave the loop slightly oversized to allow later tensioning.

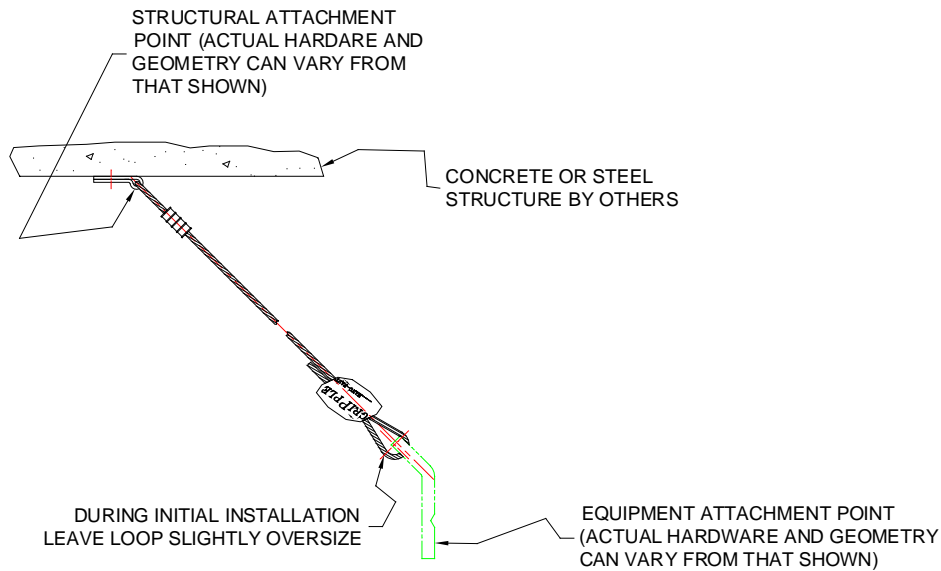

- 4) Apply a sideways load to the cable by pulling or pushing on it to fully seat the GRIPPLE.

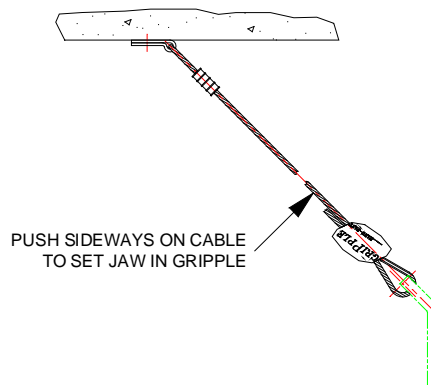

**CABLE CLAMP DETAILS**

PAGE 4 OF 7

RELEASE DATE: 10/17/05



DUBLIN, OHIO, USA • MISSISSAUGA, ONTARIO, CANADA

Toll Free (USA only): 800-959-1229  
 International: 614-889-0480  
 Fax: 614-889-0540  
 World Wide Web: www.kineticsnoise.com  
 Email: sales@kineticsnoise.com

DOCUMENT:  
**D9.5.2**



- 5) When seating the GRIPPLE, jaws will ride up an internal ramp in the GRIPPLE itself and “bite” into the cable. In a properly seated GRIPPLE, the cable will shift approximately 1-1/2 cable diameters (the preset distance) as the jaws engage. If need be, mark the cable to check the preset. This step may be required initially, but once a “feel” for it is obtained, this is no longer necessary. Once the 1-1/2 cable diameter preset dimension has been obtained, the GRIPPLE is adequately seated.

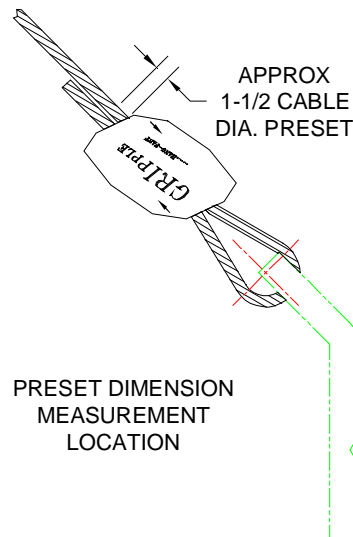

- 6) Once fully seated, any additional slack should be removed from the cable restraint by pulling on the dead end or “tail” of the cable sticking out of the GRIPPLE. If Isolated, the cables should not be made tight, but should instead be left slightly loose to prevent the transfer of vibrations into the structure. (Slightly loose could be defined as having approx 1/8 to 1/4” of visible sag in the cable – 1/8 for short cables (up to 2 ft), 1/4 for cables longer than that.)

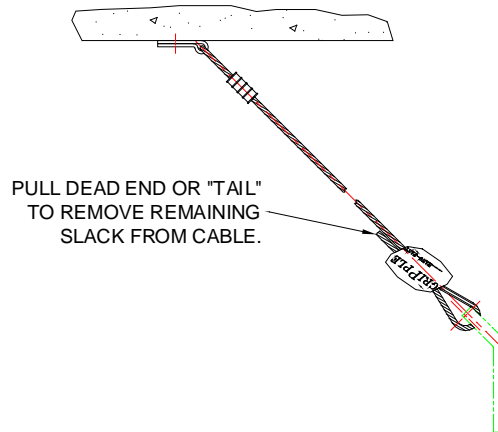

- 7) The GRIPPLE installation is now complete.

## CABLE CLAMP DETAILS

PAGE 5 OF 7

RELEASE DATE: 10/17/05



DUBLIN, OHIO, USA • MISSISSAUGA, ONTARIO, CANADA

Toll Free (USA only): 800-959-1229  
 International: 614-889-0480  
 Fax: 614-889-0540  
 World Wide Web: [www.kineticsnoise.com](http://www.kineticsnoise.com)  
 Email: [sales@kineticsnoise.com](mailto:sales@kineticsnoise.com)

DOCUMENT:

D9.5.2



## Cable Thimbles

Where sharp corners can bear against the cable loop or where vibration or other dynamic forces can cause the cable loop to abraid, a cable thimble should be used. A cable thimble fit inside the cable loop is shown in the picture below.



**Cable Thimble**

## Unacceptable Connectors

Drilled bolt Cable Connections exhibit undesirable inconsistencies in capacity if precautions are not taken during the assembly process. Undertightening these types of connections results in a loss of frictional capacity while overtightening cuts into the cable and generates premature cable failures.

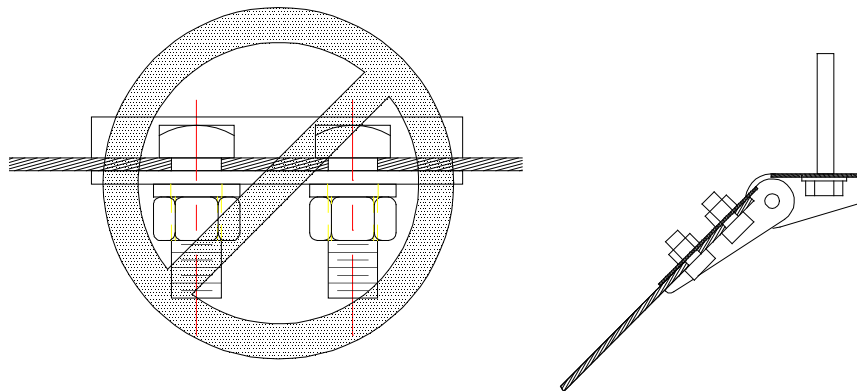

### Unacceptable Cable Connection Detail and Common Application

If used, the only consistent way to properly install cable connectors of this or similar type is with the use of a torque wrench. Variations of as little as 5 ft-lb of tightening torque can drop the tensile failure load on the cable by 30% or more. Since the use of torque wrenches or other torque-controlled devices in the field is limited, the level of confidence in the capabilities of these connections is lower than desired for critical seismic

## CABLE CLAMP DETAILS

PAGE 6 OF 7

RELEASE DATE: 10/17/05



Toll Free (USA only): 800-959-1229  
 International: 614-889-0480  
 Fax: 614-889-0540  
 World Wide Web: [www.kineticsnoise.com](http://www.kineticsnoise.com)  
 Email: [sales@kineticsnoise.com](mailto:sales@kineticsnoise.com)

DOCUMENT:  
**D9.5.2**  
 VISCMA  
 MEMBER

applications.

Because of the extreme sensitivity of the cable pull strength to the tightening torque of the bolt, drilled cable retention bolts have not been found to be acceptable by Kinetics Noise Control for use as connection hardware.

**CABLE CLAMP DETAILS**

PAGE 7 OF 7

RELEASE DATE: 10/17/05



**KINETICS**  
**Noise Control**

DUBLIN, OHIO, USA • MISSISSAUGA, ONTARIO, CANADA

Toll Free (USA only): 800-959-1229  
International: 614-889-0480  
Fax: 614-889-0540  
World Wide Web: [www.kineticsnoise.com](http://www.kineticsnoise.com)  
Email: [sales@kineticsnoise.com](mailto:sales@kineticsnoise.com)

DOCUMENT:  
**D9.5.2**



**VISCMA**  
MEMBER